

# Freestanding Refrigerator Freezer, 79cm, 445L, Ice & Water

Series 7 | Contemporary

Stainless Steel | Left hinge



With stylish contemporary design and large capacity, flexible storage for all your chilled and frozen foods.

- ActiveSmart™ technology to help keep food fresher for longer by stopping temperature fluctuation
- Door water dispenser and internal ice maker
- Spacious bottom freezer with full extension drawer gives easy access to frozen goods.

- Choose which side you'd like your door hinge on to suit your kitchen layout

## DIMENSIONS

Height	1715 mm
Width	790 mm
Depth	695 mm

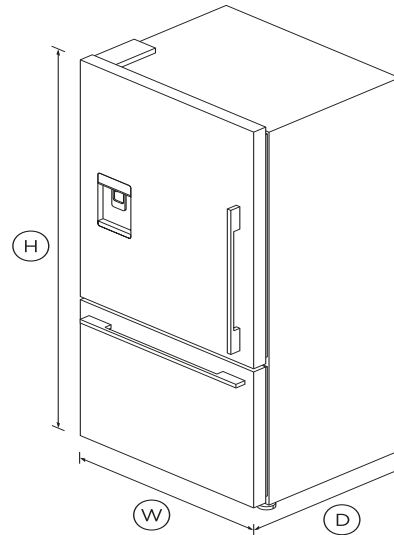

## FEATURES & BENEFITS

### ActiveSmart™ Foodcare

Every time you open your refrigerator, the temperature around your food changes. ActiveSmart™ foodcare adjusts airflow to create a stable temperature, helping your food stay fresher for longer.

### Water on tap

The slimline dispenser makes it easy to fill almost any sized jug or vessel with cool filtered water and doesn't take up any storage space in your refrigerator.

## SPECIFICATIONS

### Accessories (sold separately)

Contemporary round handle kit	Part number 25338
Joiner kit	Part number 819264
Matching Replacement Water	Models 24xxx = part no.
Surround Kit (Left Hand)	Part number 23986
Surround Kit (Right Hand)	Part number 23987

### Capacity

Freezer	103L
Refrigerator	342L
Total gross capacity	534L

### Consumption

Energy rating	A+
Energy usage	364kWh/year

### Freezer features

- Bottle chill
- Built-in ice maker
- Door alarm
- Fast freeze
- Ice Boost
- Ice bin and scoop
- Large plastic bins
- Small plastic bins

**Performance**

- ActiveSmart™ Foodcare •
- ActiveSmart™ technology •
- Adaptive defrost •
- Frost free •
- Frost free freezer •
- Humidity control system •
- Inverter controlled compressor •
- R600a refrigerant •
- Sabbath mode •

**Product dimensions**

Depth	<b>695 mm</b>
Height	<b>1715 mm</b>
Minimum air clearance - each	<b>20 mm</b>
Minimum air clearance - on top	<b>50 mm</b>
Width	<b>790 mm</b>

**Refrigerator features**

Adjustable door shelves	<b>4</b>
Adjustable glass shelves	<b>4</b>
Covered door shelves	<b>2</b>
Door alarm	•
Front levelling feet	•
Fruit and vegetable bins	<b>2</b>
Full extension runners	•
Full width door shelves	<b>2</b>
LED lighting	•
Rear rollers	•

Single bottle holders	<b>4</b>
SmartTouch control panel	•
Stackable bottle holders	<b>4</b>
Ultra slim water dispenser	•







**Warranty**

Parts and labour	<b>5 years</b>
Sealed system parts only	<b>5 years</b>

SKU	<b>25470</b>
-----	--------------

The product dimensions and specifications in this page apply to the specific product and model. Under our policy of continuous improvement, these dimensions and specifications may change at any time. You should therefore check with Fisher & Paykel's Customer Care Centre to ensure this page correctly describes the model currently available. © Fisher & Paykel Appliances Ltd 2019.

**Other product downloads available at fisherpaykel.com**

-  [User Guide](#)
-  [Service & Warranty Booklet](#)
-  [Quick Start Guide](#)
-  [Installation Guide](#)
-  [Installation Guide \( Surround kit \)](#)
-  [Resources \(zip\)](#)
-  [Resources \(zip\)](#)



**A PEACE OF MIND SALE**

**24 Hours 7 Days a Week Customer Support**

**T 1300 650 590 W www.fisherpaykel.com**